

WORK ORDER

DATE:

JOB #:

CLIENT NAME: _____

DEALER: _____

CONTACT INFORMATION

HOME: _____ - _____ - _____

OFFICE: _____ - _____ - _____

CELL: _____ - _____ - _____

FAX: _____ - _____ - _____

MAILING ADDRESS :

SHIPPING ADDRESS:

SHIPPING DEADLINE:

INSTALLATION DEADLINE:

TYPE OF UNIT

Manual

Removable Post

Self Contained Hydraulic

Removable Latch Bars

Slim Line Hydraulic

TOWER PLACEMENT

PORT

STARBOARD

MAIN VESSEL

Make: _____

Beam: _____

Model: _____

Length: _____

Year: _____

Width of swim platform at transom: _____

Top of Swim Platform to Waterline: _____

Width of swim platform at outer edge: _____

Swim Platform Type: FIBERGLASS / SLOTTED / WOOD / ENCLOSED / ALUMINUM

DINGHY

Make: _____

Beam: _____

Model: _____

Length: _____

Year: _____

Transom Thickness: _____

Tube Diameter: _____

Steering Console: Yes No

Length of Tube from Transom Aft: _____

Top of tube to top of transom _____

Latch Pad Color:

GREY

WHITE

Note: Sea Wise Marine 2001 Inc, is not responsible for adverse wash problems or any damage occurring from the dinghy and motor being too heavy for the swim platform or the hull characteristics of the main vessel. Sea Wise Marine 2001 Inc. strongly recommends that the maximum swim platform load be confirmed by the main vessel dealer or manufacturer.

PICK THE TRANSOM STYLE THAT MOST RESEMBLES YOUR MAIN VESSEL

Diagram 1

(Side view of Main Vessel Transom & Swim Platform)

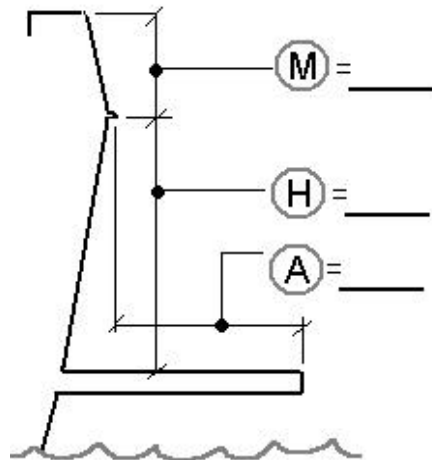

NOTES:

Transom style (1)

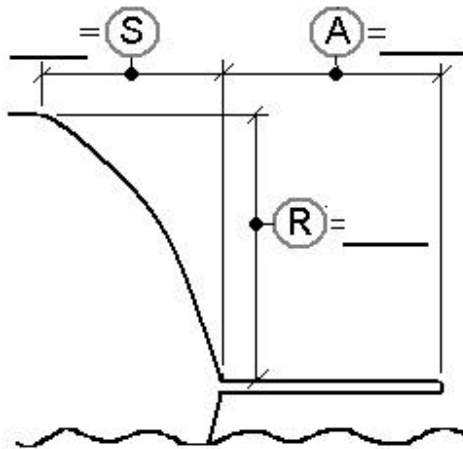

Transom Style (2)

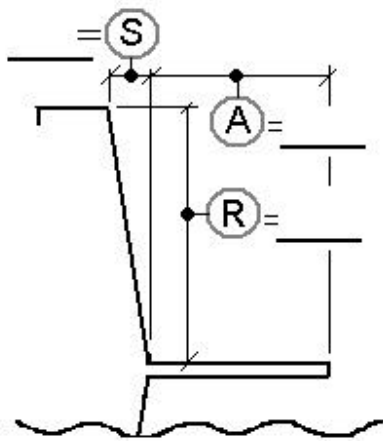

Transom Style (3)

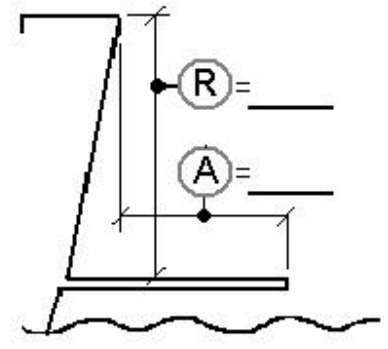

Transom Style (4)

Client Name: _____

Diagram 2

(Top View of Swim Platform)



Is there a raised lip along the top outer edge of the swim platform?

Yes

No

Please sketch any doors, lockers, ladders, etc. on the transom and swim platform, including the measurements on the above diagram.

NOTES:

Diagram 3

(Side View of Swim Platform)

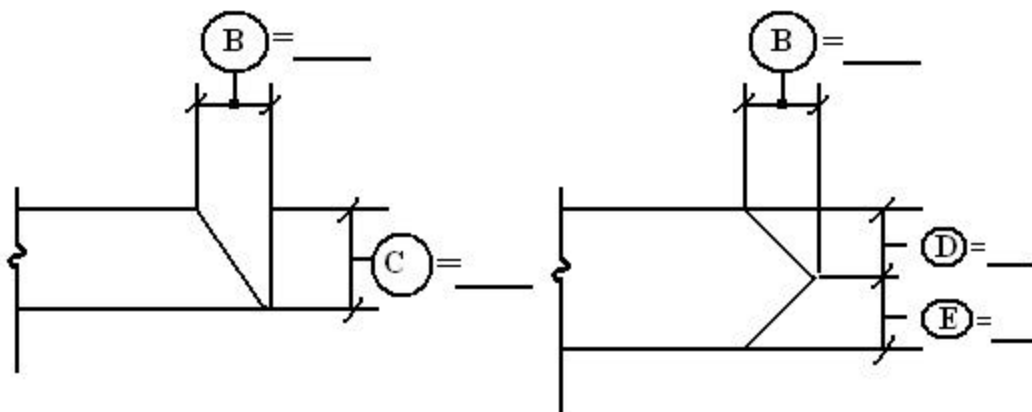

Client Name: _____

Motor Specification Sheet

Make: _____ Year: _____ HP: _____

Power Tilt:

Yes

No

Electric Start:

Yes

No

Stroke:

2 Stroke

4 Stroke

Shaft:

Short

Long

Please fill in the circles with required measurements.

Four Bolt pattern

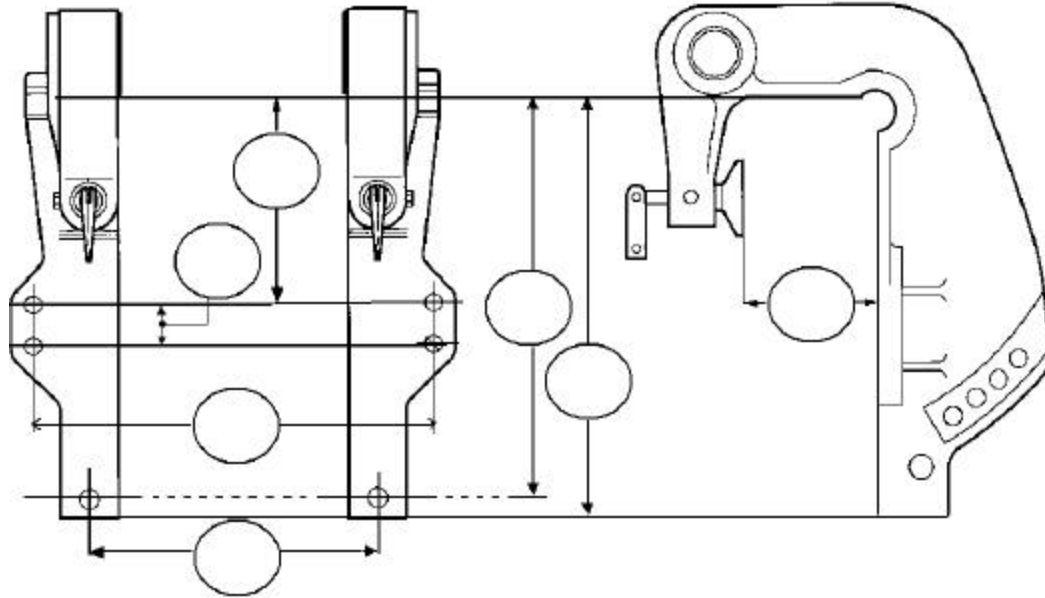

Two Bolt pattern

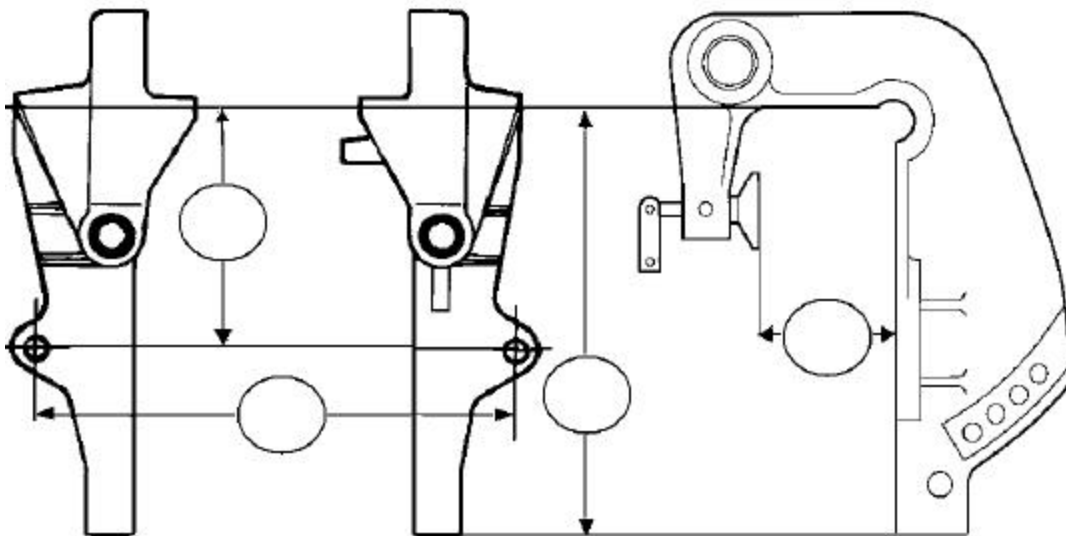

Client Name: _____

Please Note: Sea Wise Marine is not responsible for any costs incurred due to incorrect or missing information